

# PG-4832-3R-150m35CDFDA

48x32 (Euro)

Plastic Industrial Pallet

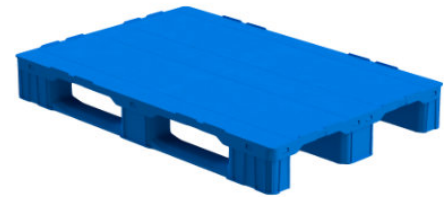

## Technical Data

Dimensions 47.2x31.5x5.9 inches (1200x800x150 mm)  
Weight 34.7 lbs

### Load Capacities

Static 11023 lbs  
Dynamic 3307 lbs  
Racking 1543 lbs

Entry 4-way  
Truckload Qty 684  
Stack TL / LTL 18 / 16

TL (truckload) and LTL (less-than-truckload) quantities are approximate and may vary by transport equipment or other factors.

## Handling Data

<b>Nestable</b> No	<b>Reusability</b> One-Way & Multi-Trip	<b>ISPM-15 Exempt</b> Yes
<b>Stackable</b> Yes	<b>Destination</b> Captive & Export	<b>Food Grade</b> FDA Blue
<b>Rackable</b> Yes	<b>Airfreight</b> Yes	<b>Pharmaceutical</b> Yes

## Materials and Colors

**Condition**  
New

**Material** HDPP  
**Color** Blue

(High-Density Polypropylene)

It is the sole responsibility of end-user to conduct a thorough risk assessment to ensure the pallet material and design are compatible with internal sanitation protocols and specific regulatory requirements.

## Deck Specs

**Top Deck**  
Closed

**Bottom Deck**  
3 Runner - Unidirectional Long Side

**Available Options:**  
PG-4832-3R-150mm33lbs - Open Deck  
Safety Rims  
Rubber and anti-slip gems / strips  
GPS/IOT Tracking Device

## Features

- Classic FDA blue color helps distinguish pallets in your system
- Virgin material may be available for direct contact applications (ask for details)
- Optimized to fit conveyors and automated systems
- Standard size used across EU
- Design is popular in rail freight applications
- Allows for safe double stacking
- Impervious to acids, fats, solvents and odors
- Resists water absorption & bacteria growth
- Inert to infestation, mold and mildew
- Consistently dimensionally accurate
- Exempt from ISPM 15 shipping regulations

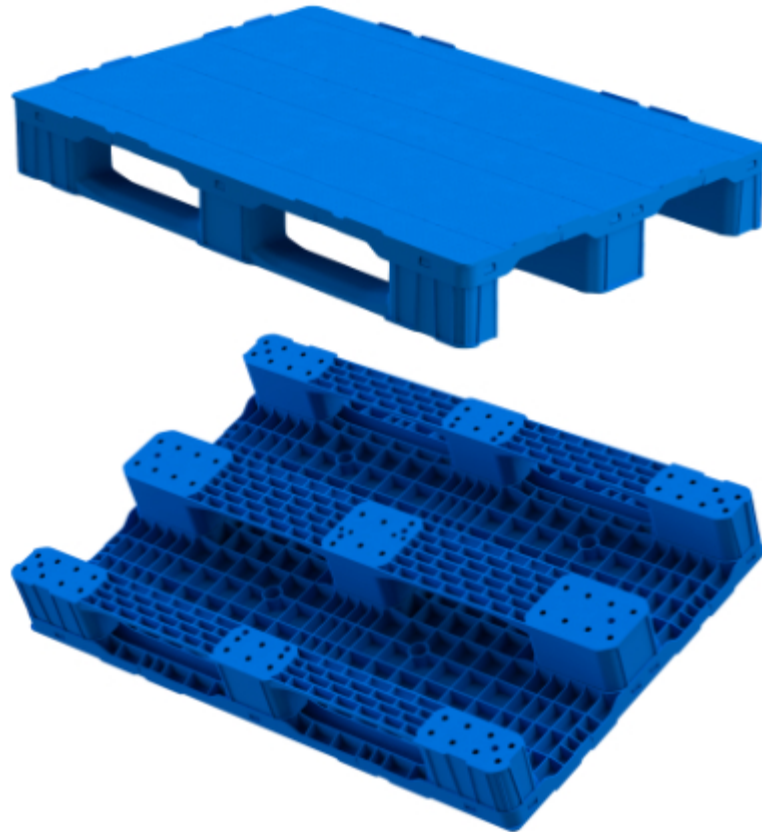

**Nelson**<sup>TM</sup>

The Nelson Company  
(443) 649-5294

[plastic@NelsonCompany.com](mailto:plastic@NelsonCompany.com)

[www.NelsonCompany.com](http://www.NelsonCompany.com)

[www.NelsonTechCenter.com](http://www.NelsonTechCenter.com)

# PG-4832-3R-150m35CDFDA

48x32 (Euro)

Plastic Industrial Pallet

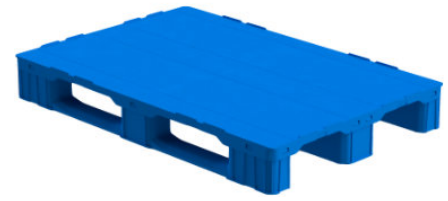

## Technical Drawings

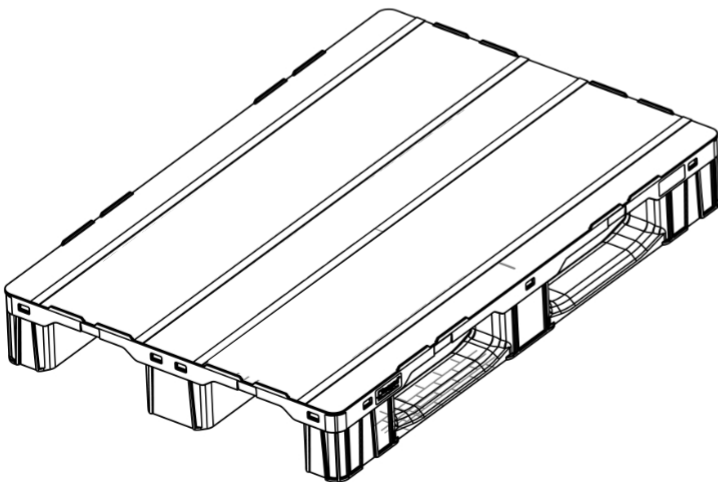
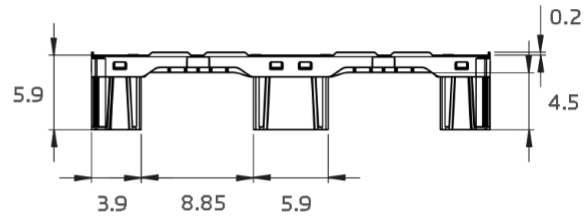
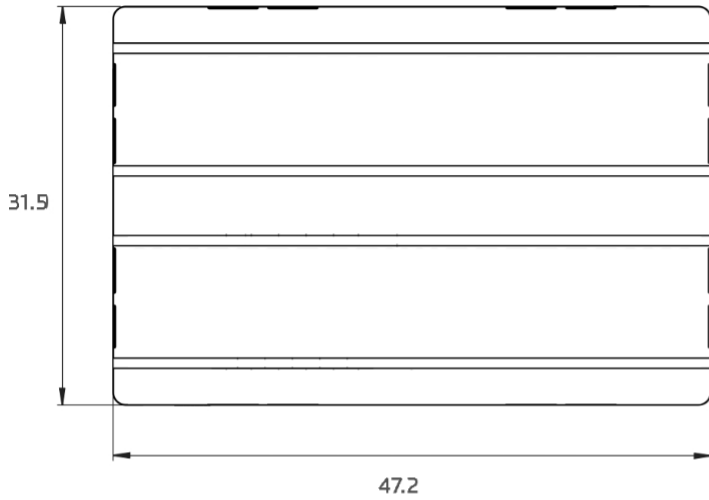
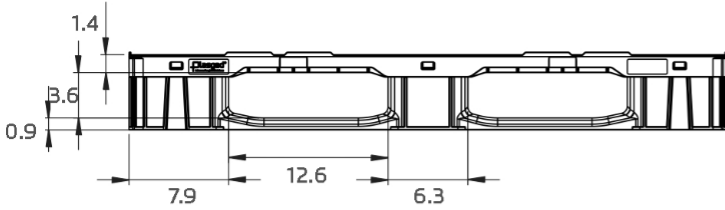

**Nelson**<sup>TM</sup>

The Nelson Company  
(443) 649-5294

[plastic@NelsonCompany.com](mailto:plastic@NelsonCompany.com)

[www.NelsonCompany.com](http://www.NelsonCompany.com)

[www.NelsonTechCenter.com](http://www.NelsonTechCenter.com)